

BRX

MOBILE POZZETTI COUNTERS

**BRX**

MOBILE POZZETTI

*MOBILE SOLUTIONS WITH FULL TECHNOLOGY OF  
A PROFESSIONAL POZZETTI*

*Intended not only for ice cream parlours but also to create gelato  
corners in restaurants, wine bars, hotels, pastry shops, cafe'-bars,  
kiosks, walking areas, events and caterings*



vintage  
**POZZETTO**  
 High Quality

*MOBILE SOLUTION FOR QUALITY GELATO*

MOBILE POZZETTI



**VINTAGE**

IS AVAILABLE IN THE MODULES 4, 6, 8 AND 10, WITH AND WITHOUT STORAGE. IT IS POSSIBLE TO PERSONALIZE THE COUNTER CHOOSING ANY COLOR FROM THE RAL LACQUERING COLORS.

WITH STORAGE

WITHOUT STORAGE

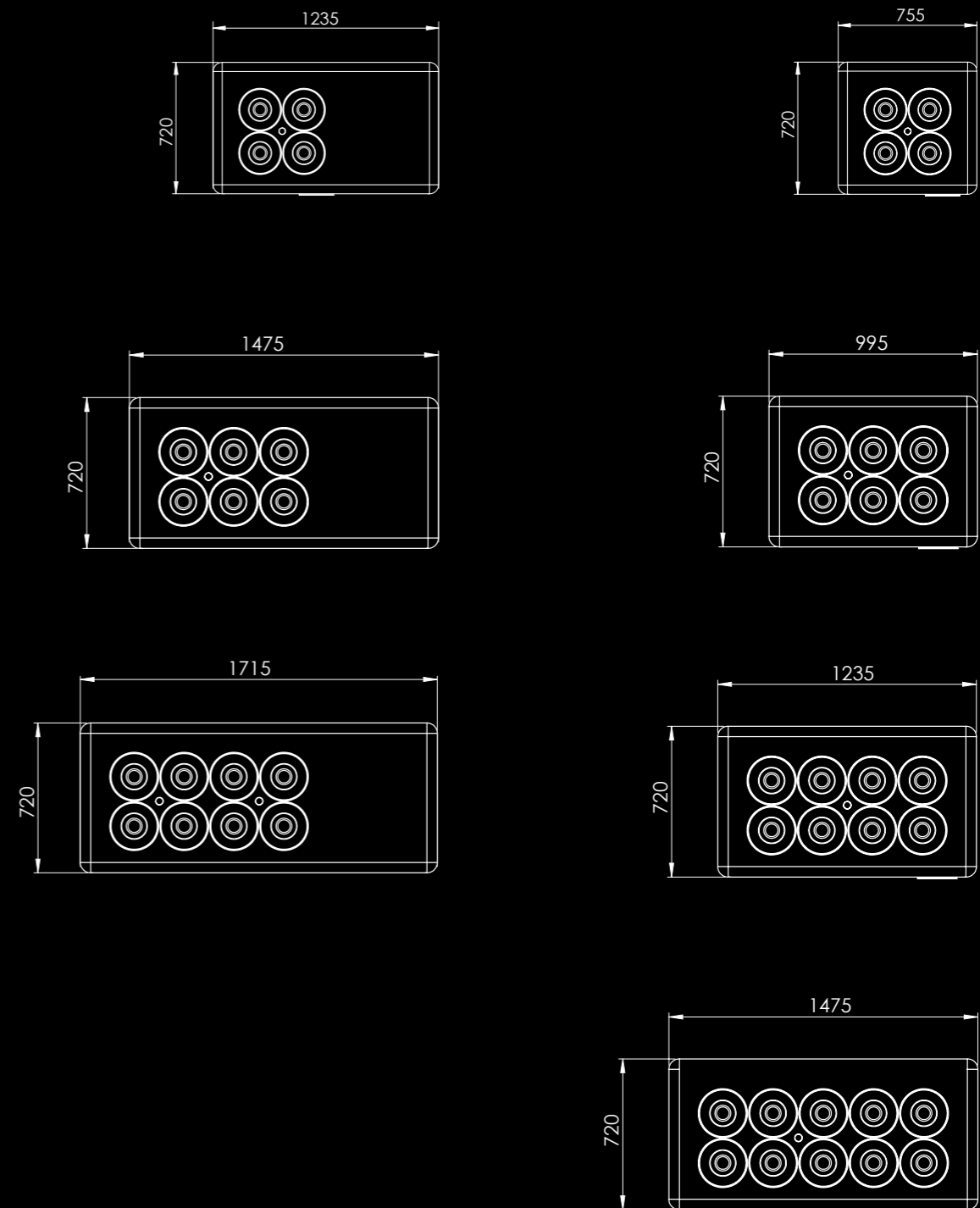

**MOBILE SOLUTION FOR QUALITY GELATO**

**MOBILE POZZETTI**



AVAILABLE BOTH GLYCOL AND COOLING VENTILATED,  
 CONTAINS THE SAME HIGH-QUALITY TECHNICAL FEATURES  
 OF OUR PROFESSIONAL RANGE OF POZZETTI GELATO

vivi

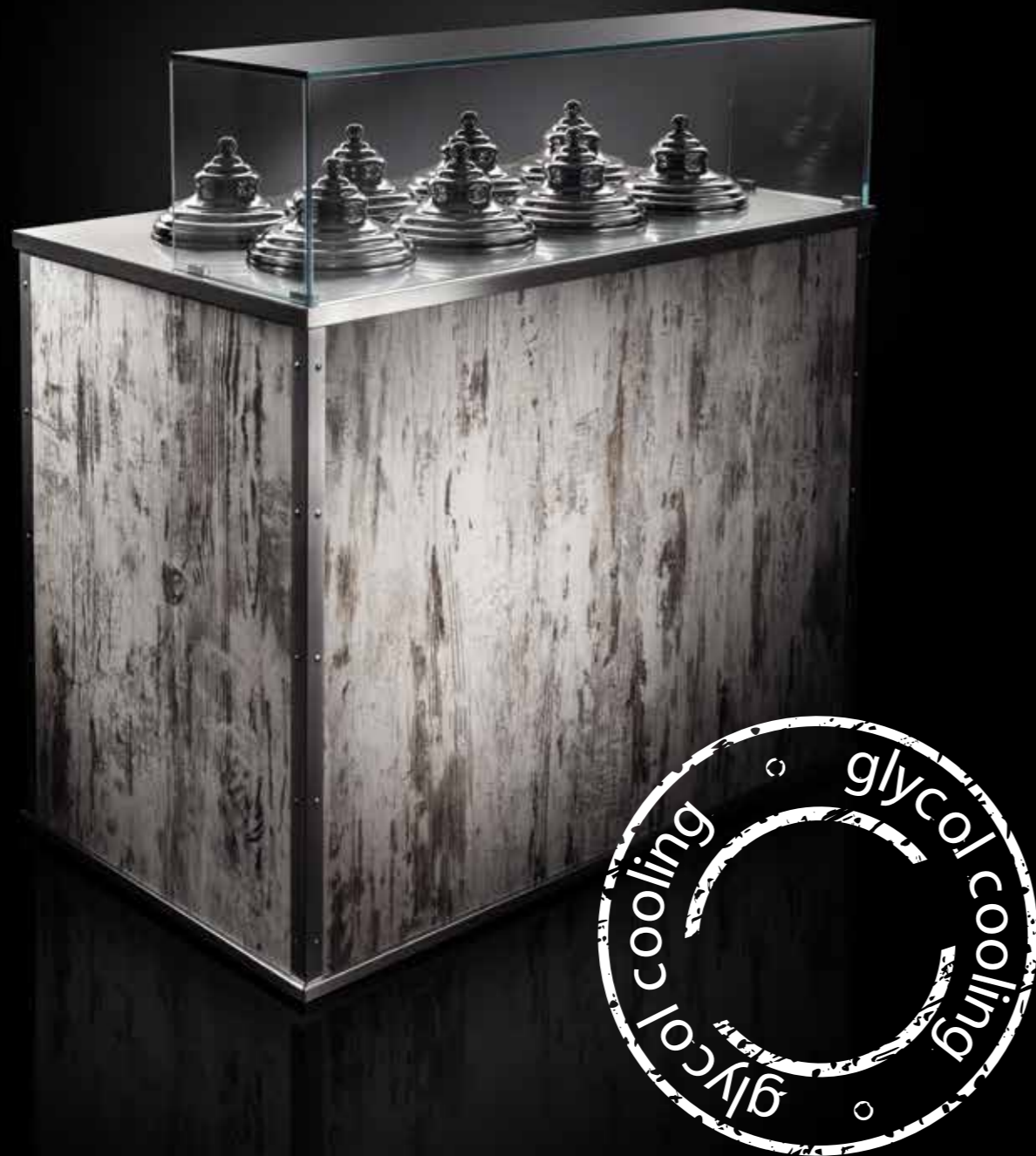

**WITHOUT STORAGE**

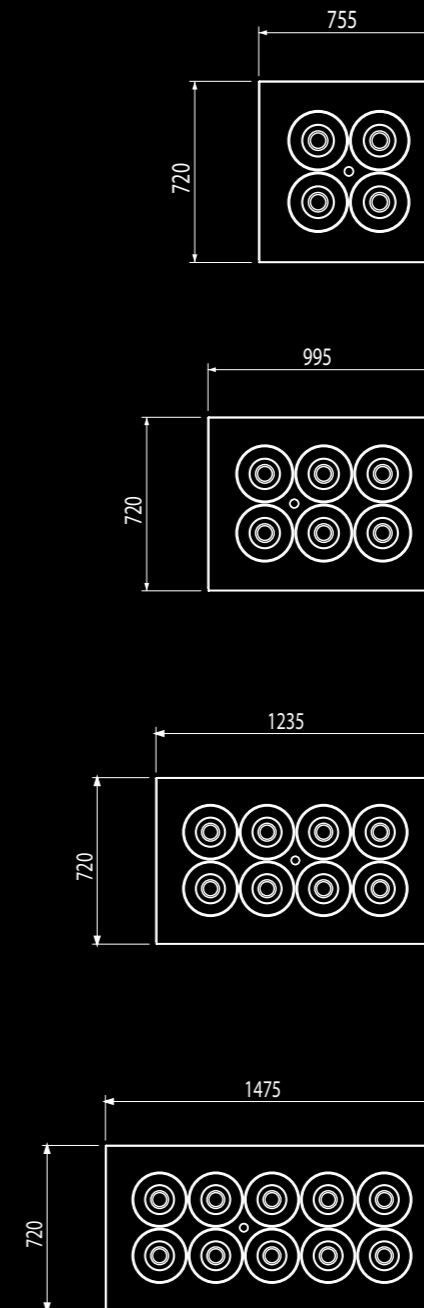

**JOY** by **BRX**  
POZZETTI GELATO & BAR TECHNOLOGY

WITH STORAGE

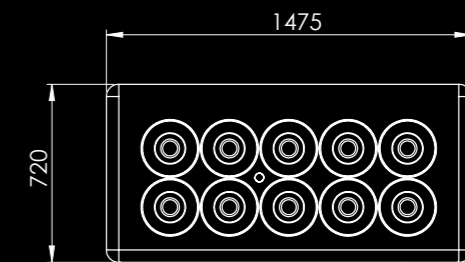
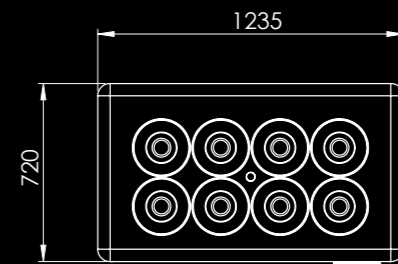
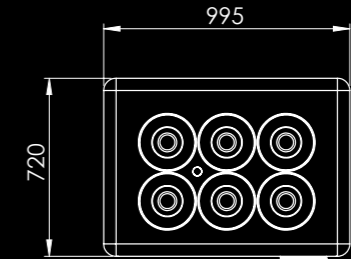
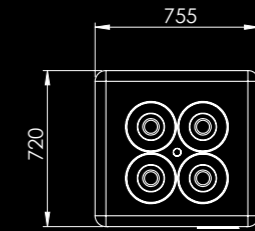



Italian Gelato Concepts Pty Limited  
Unit 1, 37 Mortimer Road  
Acacia Ridge Qld 4110

Bris Office: +61 (0) 7 3162 7724  
Syd Office +61 (0) 2 8311 9701  
Email: [info@italiangelato.com.au](mailto:info@italiangelato.com.au)

[www.italiangelato.com.au](http://www.italiangelato.com.au)

The logo for BRX features the letters "BRX" in a large, bold, white, sans-serif font. The letter "X" is stylized with a geometric, blocky design, featuring a central square with a smaller square inside it, and the top and bottom bars of the "X" are wider than the middle bar.

[WWW.BRXITALIA.COM](http://WWW.BRXITALIA.COM) +39.0721.499611